



ENTRUST

nShield Security World

nShield Solo and Solo XC v13.4.5 Install Guide

20 March 2024

Table of Contents

| | |
|---|----|
| 1. Introduction | 1 |
| 1.1. About this guide | 1 |
| 1.2. Model numbers | 1 |
| 1.3. Terminology | 1 |
| 2. Hardware security modules | 3 |
| 2.1. Electrical power requirements | 3 |
| 2.2. Handling modules | 3 |
| 2.3. Module operational temperature and humidity specifications | 3 |
| 2.4. Cooling requirements | 5 |
| 2.5. Physical location considerations | 6 |
| 3. Regulatory notices | 7 |
| 3.1. FCC class A notice | 7 |
| 3.2. Canadian certification - CAN ICES-3 (A)/NMB- 3(A) | 7 |
| 3.3. Battery cautions | 7 |
| 3.4. Hazardous substance caution | 7 |
| 3.5. Recycling and disposal information | 7 |
| 4. Before installing the module | 9 |
| 4.1. Back panel | 9 |
| 4.2. Module pre-installation steps | 10 |
| 4.3. Fitting a module bracket | 10 |
| 4.4. User Replaceable items | 11 |
| 5. Installing the module | 14 |
| 5.1. Fitting a smart card reader | 14 |
| 5.2. After installing the module | 14 |
| 6. Before you install the software | 16 |
| 6.1. Preparatory tasks before installing software | 16 |
| 6.2. Firewall settings | 19 |
| 7. Installing the software | 21 |
| 7.1. Installing the Security World Software on Windows | 21 |
| 7.2. Installing the Security World Software on Linux | 23 |
| 8. Checking the installation | 25 |
| 8.1. Checking operational status | 25 |
| 8.2. Mode switch and jumper switches | 27 |
| 8.3. Log message types | 27 |
| 8.4. BadTokenData error (Solo only) | 29 |
| 9. Status indicators | 30 |
| 9.1. Solo | 30 |

| | |
|--|----|
| 10. Uninstalling existing software | 31 |
| 10.1. Uninstalling the Security World Software on Windows | 32 |
| 10.2. Uninstalling the Security World Software on Linux | 32 |
| 11. Software packages on the Security World installation media | 34 |
| 11.1. Security World installation media | 34 |
| 11.2. Components required for particular functionality | 35 |
| 11.3. nCipherKM JCA/JCE cryptographic service provider | 36 |
| 11.4. SNMP monitoring agent | 36 |
| 12. Virtualization Remote Server | 38 |
| 12.1. Virtualization and Hyper-V | 38 |
| 12.2. Virtualization and XenServer/VMware vSphere hypervisor, ESXi | 39 |
| 12.3. ESXi environment | 39 |
| 12.4. XenServer environments | 41 |
| 12.5. Hyper-V environment | 44 |

1. Introduction

The Entrust nShield Solo and Solo XC are Hardware Security Modules (HSM) for servers and appliances.

1.1. About this guide

This guide includes:

- Installing the nShield Solo and nShield Solo XC. See [Installing the module](#).
- Installing the Security World Software. See [Installing the software](#).
- Steps to check the installation. See [Checking the installation](#).
- A description of the module status indicators. See [Status indicators](#).
- Instructions about removing existing software. See [Uninstalling existing software](#).

See the *User Guide* for your module and operating system for more about, for example:

- Creating and managing a Security World
- Creating and using keys
- Card sets
- The advanced features of the nShield Solo and the nShield Solo XC.

For information on integrating Entrust nShield products with third-party enterprise applications, see <https://www.entrust.com/digital-security/hsm>.

1.2. Model numbers

Model numbering conventions are used to distinguish different nShield hardware security devices.

| Model number | Used for |
|--------------------------|----------------------|
| nC3nnnE-nnn, nC4nnnE-nnn | nShield Solo PCIe |
| nC30n5E-nnn, nC40n5E-nnn | nShield Solo XC PCIe |

1.3. Terminology

The nShield Solo and nShield Solo XC are referred to as the *nShield Solo* and *nShield Solo XC*, the *Hardware Security Module*, or the *HSM* in this guide.

2. Hardware security modules

2.1. Electrical power requirements

| Module | Maximum power |
|-----------------|---------------|
| nShield Solo | 9.9W |
| nShield Solo XC | 24W |



Make sure that the power supply in your computer is rated to supply the required electric power.

The PCIe cards, nShield Solo and nShield Solo XC, are intended for installation into a certified personal computer, server, or similar equipment.

If your computer can supply the required electric power and sufficient cooling, you can install multiple modules in your computer.

2.2. Handling modules

The module contains solid-state devices that can withstand normal handling. However, do not drop the module or expose it to excessive vibration.



Before installing hardware, you must disconnect your computer from the power supply. Ensure that a grounded (earthed) contact remains. Perform the installation with care, and follow all safety instructions in this guide and from your computer manufacturer.



Static discharge can damage modules. Do not touch the module connector pins, or the exposed area of the module.

Leave the module in its anti-static bag until you are ready to install it. Always wear an anti-static wrist strap that is connected to a grounded metal object. You must also ensure that the computer frame is grounded while you are installing or removing an internal module.

2.3. Module operational temperature and humidity specifications

The nShield Solo module operates within the following environmental conditions.

| nShield Solo environmental conditions | Operating range | | Comments |
|---------------------------------------|-----------------|--------------|---|
| | Min. | Max. | |
| Operating temperature* | 10°C (50°F) | 35°C (95°F) | Subject to sufficient airflow |
| Storage temperature | -20°C (-4°F) | 70°C (158°F) | - |
| Operating humidity | 10% | 90% | Relative. Non-condensing at 35°C (95°F) |
| Storage humidity | 0 | 85% | Relative. Non-condensing at 35°C (95°F) |

*Air temperature at PCIe card inlet surface. For more information, see [Cooling requirements](#).

The nShield Solo XC module operates within the following environmental conditions.

| nShield Solo XC environmental conditions | Operating range | | Comments |
|--|-----------------|----------------|---|
| | Min. | Max. | |
| Operating temperature | 5°C (41°F) | 55°C (131°F) | Subject to sufficient airflow |
| Storage temperature | -5°C (-23°F) | 60°C (140°F) | - |
| Transportation temperature | -40°C (-40°F) | 70°C (158°F) | - |
| Operating humidity | 5% | 85% | Relative. Non-condensing at 30°C (86°F) |
| Storage humidity | 5% | 93% | Relative. Non-condensing at 30°C (86°F) |
| Transportation humidity | 5% | 93% | Relative. Non-condensing at 30°C (86°F) |
| Altitude | -100m (-328ft) | 2000m (6561ft) | Above Mean Sea Level |



The module is designed to operate in moderate climates only. Never operate the module in dusty, damp, or excessively hot conditions. Never install, store, or operate the module at locations where it may be subject to dripping or splashing liquids.

2.4. Cooling requirements



An air velocity of 1.9 m/s (373 LFM) is recommended for a module in operation.

During installation, ensure there is adequate airflow around the module. Airflow from fans must be directed to the inlet surface of the module such that air is flowing through and across the length of the module. To maximize airflow, use a PCIe slot with no neighboring modules if possible. If airflow is limited, consider fitting extra cooling fans.



The nShield Solo module is a passively cooled PCIe card that requires the host to provide sufficient airflow for cooling. Passive cards should not be powered without cooling airflow in place.



Ensure the module has adequate cooling. Failure to do so can result in damage to the module or computer.

To check the actual and maximum temperature of the module during operation, see the *Maintenance of nShield Hardware* section of the *User Guide* for your module and operating system. It is advised to do this directly after installing the module in its normal working environment. Monitor the temperature of the module over its first few days of operation.

2.4.1. Cooling recommendations for a desktop installation

For a desktop installation running in operating environmental conditions, dedicated airflow is required across the module. If the system cannot provide the necessary airflow, Entrust recommends you add a sufficiently powerful dedicated fan to directly cool the module. For details regarding the cooling requirements see [Cooling requirements](#).

2.4.2. Cooling recommendations for a server installation

The desktop cooling recommendations further apply to a server installation. In addition, power and airflow control software is sometimes available in a server installation. If this is the case, Entrust recommends you:

- Configure the target air velocity in the software to ensure it does not fall below the airflow recommendations of the module. For details regarding the cooling requirements, see [Cooling requirements](#).

- Ensure that the PCIe slot has been configured to fulfil the module [power requirements](#).

2.5. Physical location considerations

For the certification of Entrust nShield HSM, refer to the *Security Manual*. In addition to the intrinsic protection provided by an nShield HSM, customers must exercise due diligence to ensure that the environment within which the nShield HSMs are deployed is configured properly and is regularly examined as part of a comprehensive risk mitigation program to assess both logical and physical threats. Applications running in the environment shall be authenticated to ensure their legitimacy and to thwart possible proliferation of malware that could infiltrate these as they access the HSMs' cryptographic services. The deployed environment must adopt 'defense in depth' measures and carefully consider the physical location to prevent detection of electromagnetic emanations that might otherwise inadvertently disclose cryptographic material.

3. Regulatory notices

3.1. FCC class A notice

The nShield Solo and nShield Solo XC HSMs comply with Part 15 of the FCC rules. Operation is subject to the following two conditions:

1. The device may not cause harmful interference, and
2. The device must accept any interference received, including interference that may cause undesired operation.

This equipment has been tested and found to comply with the limits for a Class A digital device, pursuant to Part 15 of the FCC Rules. These limits are designed to provide reasonable protection against harmful interference when the equipment is operated in a commercial environment. This equipment generates, uses, and can radiate radio frequency energy and, if not installed and used in accordance with the instruction manual, may cause harmful interference to radio communications. Operation of this equipment in a residential area is likely to cause harmful interference in which case the users will be required to correct the interference at their own expense.

3.2. Canadian certification - CAN ICES-3 (A)/NMB-3(A)

3.3. Battery cautions

Danger of explosion if the battery is incorrectly replaced. The battery may only be replaced with the same or equivalent type. Dispose of the used battery in accordance with your local disposal instructions.

3.4. Hazardous substance caution

This product contains a lithium battery and other electronic components and materials which may contain hazardous substances. However, this product is not hazardous providing it is used in the manner in which it is intended to be used.

3.5. Recycling and disposal information

For recycling and disposal guidance, see the nShield product's *Warnings and Cautions* documentation.

4. Before installing the module

4.1. Back panel

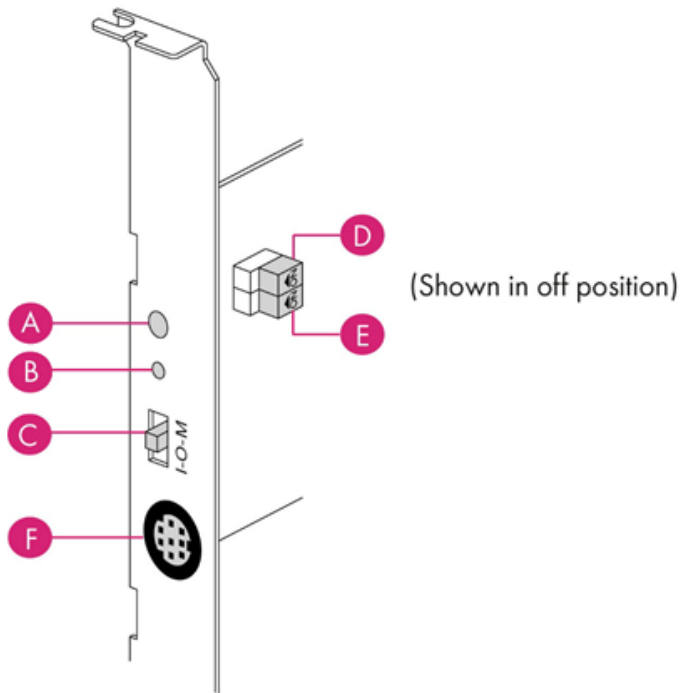

nShield Solo

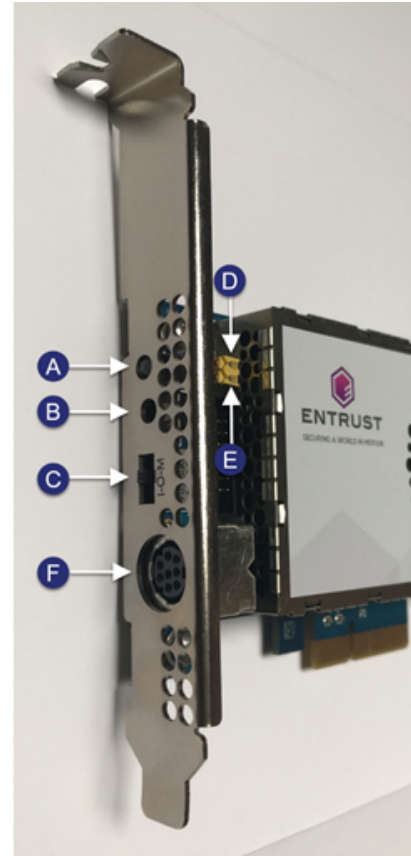

nShield Solo XC

| Label | Description |
|-------|--|
| A | Status LED |
| B | Recessed clear button |
| C | Physical mode switch |
| D | Physical mode override jumper switch, in the Off position. When set to On , the mode switch (C) is deactivated. See the <i>User Guide</i> for your module and operating system for more information. |
| E | Remote mode override jumper switch, in the Off position. When set to On , remote mode switching is disabled. See the <i>User Guide</i> for your module and operating system for more information. |
| F | A mini-DIN connector for connecting a smart card reader. |



The configuration of connectors varies between modules and might not be as in the image.

4.2. Module pre-installation steps

Check the module to ensure that there is no sign of damage or tampering:

- Check the epoxy resin security coating or the metal lid for the Solo XC for obvious signs of damage.
- If you intend to install the module with an external smart card reader, check the cable for signs of tampering. If evidence of tampering is present, do not use and request a new cable.
- Check that the two jumper switches are in the required positions.
- The physical mode switch must be set to Operational (**O**) to be able to use the remote mode switch override to change the mode. To use the Remote Administration feature to be able to change the mode of the module remotely, ensure that the jumper switch (**E**) is in the off position and the physical mode switch (**C**) is set to Operational (**O**).

The default factory setting of the jumper DIP switch **E** is **Off**. This enables remote MOI switching. Factory shipping nShield Solo HSMs loaded with firmware 2.61.2 or greater will support remote MOI switching by default. Customers who expressly do not want to enable the remote MOI switching capability must switch jump switch **E** to the **On** position.

4.3. Fitting a module bracket

Before installing a module in a PCI Express card slot, you may have to replace the bracket if it is not the same height as the slot. Both full height and low profile brackets are supplied with the module.

Do not touch the connector pins, or the exposed area of the module without taking electrostatic discharge (ESD) precautions.

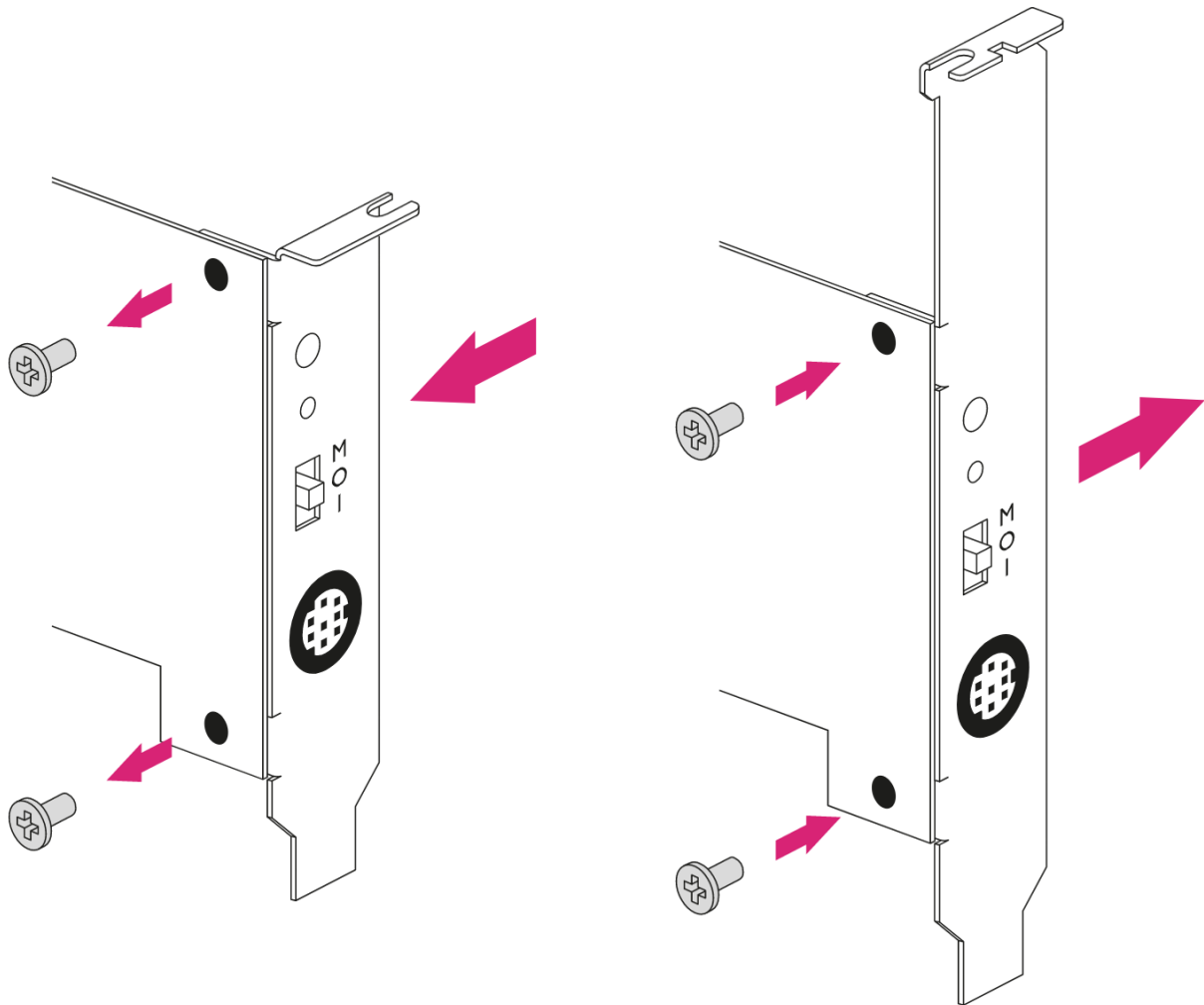

To fit the bracket to the module:

1. Remove the two screws from the solder side of the module.
2. Remove the incorrect bracket.
3. Fit the correct bracket to the component side of the module.
4. Insert the two screws into the solder side of the module to secure the bracket.
Do not over tighten the screws.

4.4. User Replaceable items

If the module has been removed so that a part can be replaced, follow these procedures before installing the module. If no parts need replacing, proceed to [Installing the module](#).

4.4.1. Replace the fan - Solo XC only

Required Tools

- Phillips screwdriver #0
- Phillips screwdriver #2
- Small needle nose pliers

Required Part

- Orderable part number SOLOXC-REP-FAN (Replacement fan assembly).
 1. Power off the system and while taking ESD precautions, remove the Solo XC card.
 2. Place the Solo XC on a flat surface.
 3. Remove the top EMI cover using a #2 screwdriver.

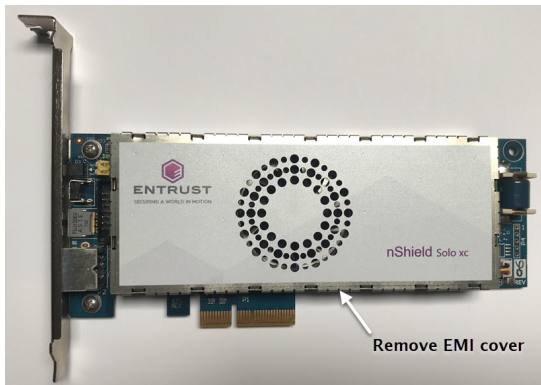

4. Pull the fan power cable and grommet from the slot in the EMI fence.
5. Using the needle nose pliers, gently remove the fan power cable from the P3 connector.

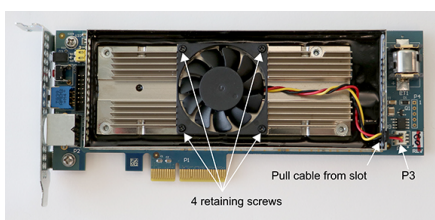

6. Using the #0 Phillips screwdriver, remove the four fan retaining screws.
7. Remove the defective fan from the Solo XC and install the replacement fan with the power cable positioned towards the P3 power connector. Ensure that the fan lays flat against the heatsink.
8. Replace the four fan retaining screws.
9. Install the power cable connector into the Solo XC P3 power connector.
10. Install the power cable grommet into the slot in the EMI fence, with the flat side towards the top of the fence.

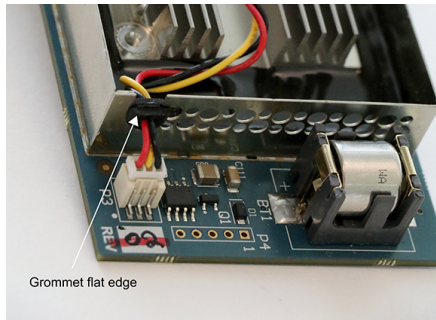

11. Replace the top EMI cover.
12. Re-install the Solo XC into the PCIe slot.

4.4.2. Replace the battery

Solo XC only



Please follow battery disposal guidelines in the installation manual.

Required tools

- Small non-conductive tweezers

Required part

- Orderable part number: SOLOXC-REP-BATT (Replacement battery)

To remove and replace the battery:

1. Power off the system and while taking ESD precautions, remove the module.
2. Place the module on a flat surface.
3. Using the tweezers, gently remove the battery from the BT1 connector.

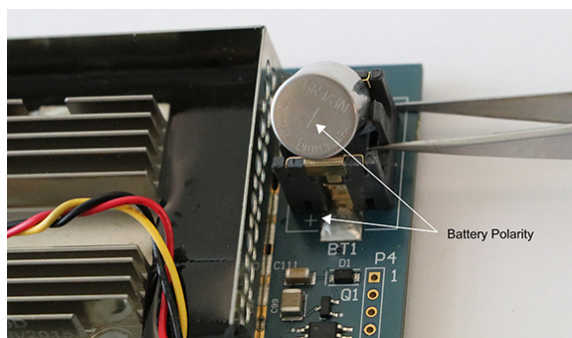

4. Observing the polarity, install the replacement battery in the BT1 connector.
5. Re-install the module into the PCIe slot.

5. Installing the module

1. Power off the system and while taking electrostatic discharge precautions, remove the module from its packaging.
2. Open the computer case and locate an empty PCIe slot. If necessary, follow the instructions that your computer manufacturer supplied.



You must only install your nShield Solo or nShield Solo XC module into a PCIe slot. See the instructions that your computer manufacturer supplied to correctly identify the slots on your computer.

Minimum requirement:

nShield Solo 1 PCIe x1 slot

nShield Solo XC 1 PCIe x4 slot

3. If there is a blanking plate across the opening to the outside of the computer, remove it. Check that the opening is large enough to enable you to access the module back panel.
4. Insert the contact edge of the module into the empty slot. Press the card firmly into the connector to ensure that:
 - The contacts are fully inserted in the connector
 - The back panel is correctly aligned with the access slot in the chassis
5. Use the bracket screw or fixing clip to secure the module to the computer chassis.
6. Check that the two jumper switches on the module are still in required positions (see [Back panel and jumper switches](#)).
7. Check that the mode switch is still in the center ● (operational) position.
8. Replace the computer case.

5.1. Fitting a smart card reader

Connect the smart card reader to the connector on the back panel of the module. A D-type to mini-DIN adapter cable is supplied with the module.

5.2. After installing the module

If the Security World software has not already been installed, you must install the Security World Software by following the instructions at [Installing the software](#).

Although methods of installation vary from platform to platform, the Security World Software should automatically detect the module on your computer and install the drivers. You do not have to restart the system.

6. Before you install the software

Before you install the software, you should:

- Install the module. See [Installing the module](#).
- Uninstall any older versions of Security World Software. See [Uninstalling existing software](#).
- If the nShield Remote Administration Client is installed on the machine, remove it. You will also have to re-install it after you installed the new Security World software version. See the *nShield Remote Administration User Guide*.
- Complete any other necessary preparatory tasks, as described in [Preparatory tasks before installing software](#).

6.1. Preparatory tasks before installing software

Perform any of the necessary preparatory tasks described in this section before installing the Security World Software.

6.1.1. Windows

6.1.1.1. Power saving options

Adjust your computers power saving setting to prevent sleep mode.

You may also need to set power management properties of the HSM, once the Security World Software is installed. See [Installing the Security World Software on Windows](#) for more information.

6.1.1.2. Install Microsoft security updates

Make sure that you have installed the latest Microsoft security updates. Information about Microsoft security updates is available from <http://www.microsoft.com/security/>.

6.1.1.3. Add %NFAST_HOME%\bin\ to the PATH environment variable

The default location for %NFAST_HOME%\bin\ is C:\Program Files\nCipher\nfast. Because of the space in **Program Files**, nShield commands could fail if **NFAST_HOME\bin** is not in **PATH**.

If you cannot change **PATH**, you will have to enclose all file names and paths that use variable between double quotation marks (" "). For example:

```
"%NFAST_HOME%\toolkits\pkcs11\cknfast.dll"
```

6.1.2. Linux

6.1.2.1. Install operating environment patches

Make sure that you have installed:

- kernel packages like **gcc**, **kernel-headers**, **kernel-devel**
- the latest recommended patches for your environment in general

See the documentation supplied with your operating environment for information.

6.1.2.2. Users and groups

The installer automatically creates the following group and users if they do not exist. If you wish to create them manually, you should do so before running the installer. Create the following, as required:

- The **nfast** user in the **nfast** group, using **/opt/nfast** as the home directory.
- If you are installing SNMP, the **ncsnmpd** user in the **ncsnmpd** group, using **/opt/nfast** as the home directory.
- If you are installing the Remote Administration Service, the **raserv** user in the **raserv** group, using **/opt/nfast** as the home directory.

6.1.3. All environments

6.1.3.1. Install Java with any necessary patches

The following versions of Java have been tested to work with, and are supported by, your nShield Security World Software:

- Java7 (or Java 1.7x)
- Java8 (or Java 1.8x)
- Java11.

Entrust recommends that you ensure Java is installed before you install the

Security World Software. The Java executable must be on your system path.

If you can do so, please use the latest Java version currently supported by Entrust that is compatible with your requirements. Java versions before those shown are no longer supported. If you are maintaining older Java versions for legacy reasons, and need compatibility with current nShield software, please contact Entrust nShield Support, <https://nshieldsupport.entrust.com>.

To install Java, you may need installation packages specific to your operating system, which may depend on other pre-installed packages to be able to work.

Suggested links from which you may download Java software as appropriate for your operating system:

- <http://www.oracle.com/technetwork/java/index.html>
- <http://www.oracle.com/technetwork/java/all-142825.html>

You must have Java installed to use KeySafe.

6.1.3.2. Identify software components to be installed

Entrust supply standard component bundles that contain many of the necessary components for your installation and, in addition, individual components for use with supported applications. To be sure that all component dependencies are satisfied, you can install either:

- All the software components supplied
- Only the software components you require

During the installation process, you are asked to choose which bundles and components to install. Your choice depends on a number of considerations, including:

- The types of application that are to use the module
- The amount of disc space available for the installation
- Your company's policy on installing software. For example, although it may be simpler to choose all software components, your company may have a policy of not installing any software that is not required.

On Windows, the **nShield Hardware Support bundle** and the **nShield Core Tools bundle** are mandatory, and are always installed.

On Windows, the **Windows device drivers** component is installed as part of the

Hardware Support bundle. On Linux, the **Kernel device drivers** component is installed.

On Linux, you *must* install the **hwsp** component.

The **Core Tools bundle** contains all the Security World Software command-line utilities, including:

- **generatekey**
- Low level utilities
- Test programs

The Core Tools bundle includes the **Tcl run time** component that installs a run-time Tcl installation within the nCipher directories. This is used by the tools for creating the Security World and by KeySafe. This does not affect any other installation of Tcl on your computer.

You need to install the Remote Administration Service component if you require remote administration functionality. See [Preparatory tasks before installing software](#) and the *User Guide* for your module and operating system for more about the Remote Administration Service.

Always install all the nShield components you need in a single installation process to avoid subsequent issues should you wish to uninstall. You should not, for example, install the Remote Administration Service from the Security World installation media, then later install the Remote Administration Client from the client installation media.

Ensure that you have identified any optional components that you require before you install the Security World Software. See [Software packages on the Security World installation media](#) for more about optional components.

6.2. Firewall settings

When setting up your firewall, you should ensure that the port settings are compatible with the HSMs and allow access to the system components you are using. The following table identifies the ports used by the nShield system components. All listed ports are the default setting. Other ports may be defined during system configuration, according to the requirements of your organization.

| Component | Default Port | Protocol | Use |
|-------------------------------|--------------|----------|---|
| Hardserver | 9000 | TCP | Internal non-privileged connections from Java applications including KeySafe |
| Hardserver | 9001 | TCP | Internal privileged connections from Java applications including KeySafe |
| Hardserver | 9004 | TCP | Incoming impath connections from other hardservers, for example: * From a cooperating client to the remote file system it is configured to access * From a non-attended host machine to an attended host machine when using Remote Operator |
| Remote Administration Service | 9005 | TCP | Incoming connections from Remote Administration Clients |
| Audit Logging syslog | 514 | UDP | If you plan to use the Audit Logging facility with remote syslog or SIEM applications, you need to allow outgoing connections to the configured UDP port |

If you are using an nShield Edge as a Remote Operator slot for an HSM located elsewhere, you need to open port 9004. You may restrict the IP addresses to those you expect to use this port. You can also restrict the IP addresses accepted by the hardserver in the configuration file. See the *User Guide* for your module and operating system for more about configuration files. Similarly, if you are setting up the Remote Administration Service you need to open port 9005.

7. Installing the software

This chapter describes how to install the Security World Software on the host computer.

After you have installed the software, you must complete further Security World creation, configuration and setup tasks before you can use your nShield environment to protect and manage your keys. See the *User Guide* for your module and operating system for more about creating a Security World and the appropriate card sets, and further configuration or setup tasks.

7.1. Installing the Security World Software on Windows

For information about configuring silent installations and uninstalls on Windows, see the *User Guide*.

For a regular installation:

1. Sign in as an Administrator or as a user with local administrator rights.



If the Found New Hardware Wizard appears and prompts you to install drivers, cancel this notification, and continue to install the Security World Software as normal. Drivers are installed during the installation of the Security World Software.

2. Place the Security World Software installation media in the optical disc drive.
3. Launch `setup.msi` manually when prompted.
4. Follow the onscreen instructions.
5. Accept the license terms and select **Next** to continue.
6. Specify the installation directory and select **Next** to continue.
7. Select all the components required for installation.

By default, all components are selected. Use the drop-down menu to deselect the components that you do not want to install. **nShield Hardware Support** and **Core Tools** are necessary to install the Security World Software.

See [Software packages on the Security World installation media](#) for more about the component bundles and the additional software supplied on your installation media.

8. Select **Install**.

The selected components are installed in the installation directory chosen above. The installer creates links to the following nShield Cryptographic Service Provider (CSP) setup wizards as well as remote management tools under **Start > Entrust** or **Entrust nShield Security World** (depending on the version of Windows or Windows Server you are running):

- If **nShield CSPs (CAPI, CNG)** was selected: **32bit CSP install wizard**, which sets up CSPs for 32-bit applications
- If **nShield CSPs (CAPI, CNG)** was selected: **64bit CSP install wizard**, which sets up CSPs for 64-bit applications
- If **nShield CSPs (CAPI, CNG)** was selected: **CNG configuration wizard**, which sets up the CNG providers
- If **nShield Java** was selected: **KeySafe**, which runs the key management application
- If **nShield Remote Administration Client Tools** was selected: **Remote Administration Client**, which runs the remote administration client

If selected, the SNMP agent will be installed, but will not be added to the **Services** area in **Control Panel > Administrative Tools** of the target Windows machine. If you wish to install the SNMP agent as a service, please consult the *SNMP monitoring agent* section in the *User Guide* for your module and operating system.



Do not run any CSP installation wizard before installing the module hardware.

9. Select **Finish** to complete the installation.

The following global variables are set upon install:

- **%NFAST_CERTDIR%**
- **%NFAST_HOME%**
- **%NFAST_KMDATA%**
- **%NFAST_LOGDIR%**

You may additionally need to do the following after you have installed the software:

- In **Windows Device Manager > Security Accelerator**, select the appropriate module.

- Under **Properties > Power Management**, deselect **Allow the computer to turn off this device to save power**.

7.2. Installing the Security World Software on Linux



In the following instructions, *disc-name* is the name of the mount point of the installation media.

1. Sign in as a user with root privileges.
2. Mount the DVD/ISO image.
3. Open a terminal window, and change to the root directory.
4. Extract the required `.tar.gz` files to install all the software bundles by running commands of the form:

```
sudo mkdir /opt/nfast
sudo tar xzf /<iso-mountpoint>/linux/amd64/<file>.tar.gz -C /opt/nfast/
```

In this command, `<file>` is the name of a `.tar.gz` file for that component, for example `hwsp.tar.gz`.

See [Software packages on the Security World installation media](#) for more about the component bundles and the additional software supplied on your installation media.

5. To use an nShield module with your Linux system, you must build a kernel driver. Entrust supplies the source to the NFP and a makefile for building the driver as a loadable module.

The kernel level driver is installed as part of the `hwsp` bundle. To build the driver with the supplied makefile, you must have the correct headers installed for the kernel that you are running. They must be headers for the same version of the kernel and must contain the kernel configuration options with which your kernel was built. You must also have appropriate versions of `gcc`, `make`, and your C library's development package.

The configuration script looks for the kernel headers in the default directory `/lib/modules/'<uname -r>'/build/include/`. If your kernel headers are located in a different directory, set the `KERNEL_HEADERS` environment variable so that they are in `$KERNEL_HEADERS/include/`. Historically, the headers have resided in `/usr/src/linux/include/`. If the headers for your kernel are not already installed, install them from your Linux distribution disc, or contact your kernel supplier.

Build the driver as a loadable kernel module. When you have ensured the correct headers are in place, perform the following steps to use the makefile:

- a. Change directory to the nShield PCI driver directory by running the command:

```
# cd /opt/nfast/driver/
```

- b. Configure the source by running the command:

```
./configure
```

- c. Make the driver by running the command:

```
# make
```

This produces a driver file that is automatically loaded as part of the normal installation process.

6. Run the install script by using the following command:

```
/opt/nfast/sbin/install
```

7. Sign in to your normal account.
8. Add `/opt/nfast/bin` to your `PATH` system variable:

If you use the Bourne shell, add these lines to your system or personal profile:

```
PATH=/opt/nfast/bin:$PATH  
export PATH
```

If you use the C shell, add this line to your system or personal profile:

```
setenv PATH /opt/nfast/bin:$PATH
```

8. Checking the installation

This section describes what to do if you have an issue with the module or the software.



The facilities described below are only available if the software has been installed successfully.

8.1. Checking operational status

8.1.1. Enquiry utility

Run the **enquiry** utility to check that the module is working correctly. You can find the **enquiry** utility in the **bin** subdirectory of the **nCipher** directory. This is usually:

- **C:\Program Files\nCipher\nfast** for Windows
- **/opt/nfast** for Linux

If the module is working correctly, the **enquiry** utility returns a message similar to the following:

nShield Solo

```
Server:
enquiry reply flags      none
enquiry reply level     Six
serial number           #####-####
mode                    operational
version                 #.#.#
speed index             ###
rec. queue              ##.##
...
version serial          #
remote server port      #####
...
module type code        0
product name            nFast server
...
Module ##:
enquiry reply flags      none
enquiry reply level     Six
serial number           #####-####
mode                    operational
version                 #.#.#
speed index             ###
rec. queue              ##.##
...
module type code        7
product name            #####/#####/#####
...
rec. LongJobs queue     ##
SEE machine type       Power PCSXF
```

```
supported KML types  DSAp1024s160 DSAp3072s256
hardware status      OK
```

nShield Solo XC

```
Server:
enquiry reply flags  none
enquiry reply level Six
serial number       #####-####
mode                operational
version             #.#.#
speed index         ###
rec. queue          ##.##
...
module type code    0
product name        nFast server
...
version serial      #
remote server port  #####

Module ##:
enquiry reply flags  none
enquiry reply level Six
serial number       #####-####
mode                operational
version             #.#.#
speed index         ###
rec. queue          ##.##
...
module type code    12
product name        #####/#####/#####
...
rec. LongJobs queue ##
SEE machine type    Power PCELF
supported KML types DSAp1024s160 DSAp3072s256
hardware status      OK
```

If the mode is operational the module has been installed correctly.

If the mode is initialization or maintenance, the module has been installed correctly, but you must change the mode to operational. See the *User Guide* for your module and operating system for more about changing the module mode.

If the output from the `enquiry` command says that the module is not found, first restart your computer, then re-run the `enquiry` command.



If the operating system supports power saving, disable power saving. See [Installing the module](#) for more information. Otherwise, if your system enters Sleep mode, the HSM may not be found when running `enquiry`. If this happens, you need to reboot your system.

8.1.2. nFast server (hardserver)

Communication can only be established with a module if the nFast server is running. If the server is not running, the `enquiry` utility returns the message:

```
NFast_App_Connect failed: ServerNotRunning
```

Restart the nFast server, and run the `enquiry` utility again. See the *User Guide* for your module and operating system for more about how to restart the nFast server.

8.2. Mode switch and jumper switches

The mode switch on the back panel controls the mode of the module. See the *User Guide* for your module and operating system for more about checking and changing the mode of an HSM. You can set the physical mode override jumper switch on the circuit board of the nShield Solo to the **On** position, to prevent accidental operation of the mode switch. If this override jumper switch is on, the nShield Solo and nShield XC Solo XC will ignore the position of the mode switch (see [Back panel and jumper switches](#)).



You can set the remote mode override jumper switch on the circuit board of the nShield Solo and nShield Solo XC to the **On** position to prevent mode change using the `nopclearfail` command. This should be done if, for example, the security policies of your organization require the physical mode switch to be used to authorize mode changes.

8.3. Log message types

By default, the hardserver writes log messages to:

- The in Windows Operating System event log.
- `log/logfile` in the `nCipher` directory (normally `opt/nfast/log` directory) on Linux. The environment variable `NFAST_SERVERLOGLEVEL` determines what types of message you see in your log. The default is to display all types of message. For more information on `NFAST_SERVERLOGLEVEL`, see the *User Guide* for your module and operating system.



`NFAST_SERVERLOGLEVEL` is a legacy debug variable.

8.3.1. Information

This type of message indicates routine events:

```
nFast Server service: about to start  
nFast Server service version starting  
nFast server: Information: New client clientid connected  
nFast server: Information: New client clientid connected - privileged  
nFast server: Information: Client clientid disconnected  
nFast Server service stopping
```

8.3.2. Notice

This type of message is sent for information only:

```
nFast server: Notice: message
```

8.3.3. Client

This type of message indicates that the server has detected an error in the data sent by the client (but other clients are unaffected):

```
nFast server: Detected error in client behaviour: message
```

8.3.4. Serious error

This type of message indicates a serious error, such as a communications or memory failure:

```
nFast server: Serious error, trying to continue: message
```

If you receive a serious error, even if you are able to recover, contact Support.

8.3.5. Serious internal error

This type of message indicates that the server has detected a serious error in the reply from the module. These messages indicate a failure of either the module or the server:

```
nFast server: Serious internal error, trying to continue: message
```

If you receive a serious internal error, contact Support.

8.3.6. Start-up errors

This type of message indicates that the server was unable to start:

```
nFast server: Fatal error during startup: message nFast Server service version failed init.  
nFast Server service version failed to read registry
```

Reinstall the server as described in the *User Guide* for your module and operating system. If this does not solve the problem, contact Support.

8.3.7. Fatal errors

This type of message indicates a fatal error for which no further reporting is available:

```
nFast server: Fatal internal error
```

or

```
nFast server: Fatal runtime error
```

If you receive either of these errors, contact Support.

8.4. BadTokenData error (Solo only)

The PCIe module (not the Solo XC module) is equipped with a rechargeable backup battery for maintaining Real-Time Clock (RTC) operation when the module is powered down. This battery typically lasts for two weeks. If the module is without power for an extended period, the RTC time is lost. When this happens, attempts to read the clock (for example, using the `ncdate` or `rtc` utilities) return a **BadTokenData** error status.

The correct procedure in these cases is to reset the clock and leave the module powered up for at least ten hours to allow the battery to recharge. No other nonvolatile data is lost when this occurs. See the *User Guide* for your module and operating system for more about resetting the clock.

The Solo XC module is equipped with a battery with a ten year life for maintaining RTC operation when the module is powered down. The RTC will not require resetting after the module has been shut down for extended periods. The battery is not rechargeable.

9. Status indicators

9.1. Solo

The blue Status LED indicates the operational status of the module.

| Status LED | Description |
|---|---|
| Off. | <p>Status: Power off</p> <p>There is no power supply to the module. Check that the module is correctly inserted in its PCIe slot, then restart the computer.</p> |
| On, occasionally blinks off. | <p>Status: Operational mode</p> <p>The nShield Solo module is accepting commands. The more frequently the Status LED blinks off, the greater the load on the module.</p> |
| Flashes two short pulses, followed by a short pause. | <p>Status: Initialization mode</p> <p>Used to create and load Security World data on the HSM and to erase Security World from the HSM and return it to factory state.</p> |
| Flashes two long pulses followed by a pause. | <p>Status: Maintenance mode</p> <p>Used for reprogramming the module with new firmware. The module only goes into Maintenance mode during a software upgrade.</p> |
| Flashes SOS, the Morse code distress code (three short pulses, three long pulses, three short pulses). After flashing SOS, the Status LED flashes an error code in Morse code. | <p>Status: Error mode</p> <p>If the module encounters an unrecoverable error, it enters Error mode. In Error mode, the module does not respond to commands and does not write data to the bus.</p> <p>For nShield Solos and nShield Solo XCs running firmware Remote Administration 2.61.2 and above, the error code is also reported by the enquiry utility in the hardware status field of the Module.</p> <p>If a command does not complete successfully, the module normally writes an error message to the log file and continues to accept further commands. It does not enter Error mode. For information about error codes, see the <i>User Guide</i> for your module and operating system.</p> |



Use the mode switch to move between Maintenance, Operational, and Initialization modes. See [Mode switch and jumper switches](#) for more information.

10. Uninstalling existing software

Entrust recommends that you uninstall any existing older versions of Security World Software before you install new software. In Windows environments, if the installer detects an existing Security World Software installation, it asks you if you want to install the new components. These components replace your existing installation.

The automated Security World software installers do not delete user created components, key data, or Security World data. However, on Linux, a manual installation using `.tar` files *does* overwrite existing data and directories.



Before you uninstall the Security World Software, Entrust strongly recommends that you make a secure backup of any existing Security World and nShield configuration files. See the *User Guide* for more information.



When upgrading the Security World Software, you do NOT need to delete key data or any existing Security World. If you want to do so for other reasons, see the *User Guide* for your module and operating system for more information. If you do delete Security World data, it cannot be restored unless you have an up-to-date backup and a quorum of the Administrator Card Set (ACS) is available.



The file `nCipherKM.jar`, if present, is located in the `extensions` folder of your local Java Virtual Machine. The uninstall process may not delete this file. Before reinstalling over an old installation, remove the `nCipherKM.jar` file. See the *User Guide* for your module and operating system for more about locating the Java Virtual Machine `extensions` folder.



You can only have a single Security World Software installation on a computer at a time



If you are downgrading a software authenticated client to a Security World Software earlier than version 12.60, the client will need to be re-enrolled as software-based authentication is not supported. See the *Configuring the nShield Connect to use the client* section in the *nShield Connect User Guide* for more information.



Entrust recommends that you do not uninstall the Security World Software unless you are either certain it is no longer required, or you intend to upgrade it.

10.1. Uninstalling the Security World Software on Windows

Before uninstalling the Security World software, you should back up your `%NFAST_HOME%` directory. Delete this backup after upgrading the Security World and confirming that the configuration files and any customizations are correct.

1. Open the **Control Panel** and select **Programs and Features**.
2. For the following programs, select **Uninstall** and follow the on-screen instructions:
 - **nShield Security World Software**
 - **CyberJack Base Components**

10.2. Uninstalling the Security World Software on Linux

Before uninstalling the Security World software, back up your `$NFAST_HOME` directory. This preserves your key management data, `hardserver.d`, and any data customizations.

When upgrading the Security World, restore the backup to preserve your PKCS #11 and Soft KNETI authentication settings and any customizations. If you delete the `/opt/nfast` directory without making a copy of it, you will lose these configuration settings.

When restoring a Security World from a backup, you need to maintain permissions.



If you are doing a clean reinstallation of the Security World software, ensure you backup the following files and folders before uninstalling:

- `/opt/nfast/kmdata`

Do not delete `/etc/nfast/config` nor the `nfast` and `ncsnmpd` users.

1. Assume the nFast Administrator privileges or root privileges by running the command:

```
$ su -
```

2. Type your password, then press **Enter**.
3. To remove drivers, install fragments, and scripts and to stop services, run the command:

```
/opt/nfast/sbin/install -u
```

4. Delete all the files (including those in subdirectories) in `/opt/nfast` and `/dev/nfast/` by running the following commands:

```
rm -rf /opt/nfast  
rm -rf /dev/nfast
```

5. If you are not reinstalling the product, delete the configuration file `/etc/nfast.conf` if it exists.
6. Unless needed for a new installation, remove the user `nfast` and, if it exists, the user `ncsnmpd` using `sudo userdel` and `sudo groupdel`. For example:

```
sudo userdel ncsnmp  
sudo userdel nfast  
sudo groupdel ncsnmp  
sudo groupdel nfast
```

If required, you can safely remove the module after shutting down all connected hardware.

11. Software packages on the Security World installation media

This appendix lists the contents of the component bundles and the additional software supplied on your Security World Software installation media. For information on installing the supplied software, see [Installing the software](#).

Entrust supply the hardware server and associated software as bundles of common components that provide much of the required software for your installation. In addition to the component bundles, provide individual components for use with specific applications and features supported by certain Entrust modules.

To list installed components, use the `nversions` command-line utility.

11.1. Security World installation media

The following component bundles and additional components are supplied on the Security World installation media:

11.1.1. Component bundles

| Linux Package | Windows Feature in the Installer | Content |
|---------------------|----------------------------------|---|
| <code>hwsp</code> | nShield Hardware Support | Hardware Support package, including the nShield Server and device driver. |
| <code>ctls</code> | nShield Core Tools | Management utilities, including generatekey, diagnostic and performance tools, Remote Administration Client cmd, and the PKCS#11 library. |
| <code>ctd</code> | nShield Cipher Tools | Developer package example programs, and developer libraries for the nCore API and generic stub. |
| <code>devref</code> | nShield Developer Reference | Reference Documentation for the nCore API. |
| N/A | nShield CSPs (CAPI, CNG) | CAPI and CNG providers and associated tools. |
| N/A | nShield Debug | PDB and .map files for nShield libraries and executables. |

| Linux Package | Windows Feature in the Installer | Content |
|---------------|--|---|
| N/A | nShield Device Drivers | Device drivers for PCI and USB attached nShield devices, included in hwsp for Linux. |
| javasp | nShield Java | nCipherKM JCA/JCE Provider, associated classes (including nFast Java generic stub classes) and the KeySafe application. |
| jd | nShield Java Developer | Java developer libraries and documentation for the nCore API and generic stub. |
| ncsnmp | nShield SNMP | nShield SNMP service and tools. |
| N/A | nShield Remote Administration Client Tools | Remote Administration Client tools and shortcuts. |
| N/A | nShield Trusted Verification Device | Driver for the Trusted Verification Device (TVD), included in ctl5 for Linux. |
| raserv | nShield Remote Administration Server | nShield Remote Administration server for enabling communication between remote clients and their Type3 smartcards and this machine. |
| redist | N/A | Contains the redistributable GNU C and C++ shared libraries. |

11.2. Components required for particular functionality

Some functionality requires particular component bundles or individual components to be installed.

Support for nShield Edge is shipped by default as part of the nShield Hardware Support component.

Ensure that you have installed the **Hardware Support (mandatory)** and **Core Tools (mandatory)** components.

In these part codes, *n* represents any integer.

If you are developing in Java, install the **Java Developer** and **Java Support (including KeySafe)** bundles; after installation, ensure that you have added the **.jar** files to your **CLASSPATH**.

You must install the **hwsp** component if you are using an nShield PCI card.

11.2.1. KeySafe

To use KeySafe, install the nShield **Core Tools** (`ctls` on Linux) and the nShield **Java** (`javasp` on Linux) components.

11.2.2. Microsoft CAPI CSP and Microsoft Cryptography API: Next Generation (CNG)

If you require the Microsoft CAPI CSP, you must install the nShield CSPs (CAPI, CNG) component.

If you want to use the module with PKCS #11 applications, including release 4.0 or later of Netscape Enterprise Server, Sun Java Enterprise System (JES), or Netscape Certificate Server 4, install the nShield PKCS11 library. For detailed PKCS #11 configuration options, see:

- The appropriate *User Guide* for your module and operating system
- The appropriate third-party integration guide for your application

Integration guides for third-party applications are available from <https://nshieldsupport.entrust.com>.

11.3. nCipherKM JCA/JCE cryptographic service provider

If you want to use the nCipherKM JCA/JCE cryptographic service provider, you must install:

- The nShield Java bundle

An additional JCE provider `nCipherRSAPrivateEncrypt` is supplied that is required for RSA encryption with a private key. To install and use this provider, ensure that the `nCipherKM.jar` is in your `CLASSPATH` or `MODULEPATH`. You will also need to add the following classname to the top of the list of providers in your `java.security` file `com.ncipher.fixup.provider.nCipherRSAPrivateEncrypt`

See the *User Guide* for your module and operating system for more about configuring the nCipherKMJCA/JCE cryptographic service provider.

11.4. SNMP monitoring agent

If you want to use the **SNMP monitoring agent** to monitor your modules, install the nShield SNMP component (`ncsnmp` on Linux).

During the first installation process of the SNMP agent, the agent displays the following message:

If this is a first time install, the nShield SNMP Agent will not run by default.
Please see the manual for further instructions.

See the *User Guide* for your module and operating system for more about how to activate the SNMP agent after installation.

12. Virtualization Remote Server

Virtualization provides an environment where multiple operating systems can run at the same time on one physical computer. Each virtual machine is an isolated, virtualized computer system that can run its own operating system.

The nShield Solo XC is compatible with the leading server virtualization and hypervisor management platforms, including:

- **Microsoft Hyper-V**, a role in Windows Server used to create and manage a virtualized server computing environment
- **VMware vSphere / ESXi**, a robust, bare-metal hypervisor that installs directly onto your physical server.

All vSphere management functions are performed through remote management tools.

- **Citrix XenServer** - includes the XenCenter management console.

PCI passthrough is configured using the XenCenter software with command line tools and utilities. PCI passthrough allows a VM client direct access to the nShield Solo XC.



The operating system that runs within a virtual machine is referred to as a *guest operating system*.

nShield software includes the nShield hardserver applications. These applications enable applications running on multiple virtual guest operating systems to all share nShield Solo XC hardware.

Hardserver processing services can be shared among multiple virtual operating system instances as long as each instance has hardserver installed. Inside of the operating system, hardservers can communicate with other hardservers.

12.1. Virtualization and Hyper-V

The host hardserver is configured to run on the Parent/Dom0 operating system. The Parent/Dom0 operating system has privileged access to the Solo XC hardware over the PCI bus.

Instead of using a physical network for communication between the VM guest instances running on the same physical system, most hypervisors provide the capability to instantiate some form of virtual switch which allows the network

communication to take place between the VMs entirely within the hypervisor software. This means that nCore data does not need to be routed outside of the server hardware.

12.2. Virtualization and XenServer/VMware vSphere hypervisor, ESXi

ESXi and XenServer do not use the concept of a Parent/Dom0 VM. Instead, an additional VM is defined in the system as the host with passthrough permissions to enable access to the nShield Solo XC.

12.3. ESXi environment

After installing VMware ESXi, the VM guest can be remotely managed and the PCI passthrough of the Solo module configured using vSphere. PCI passthrough allows a VM guest direct access to the nShield Solo XC.

12.3.1. Set up a basic single-node vCenter server instance

Follow the steps below to use the vCenter Simple Install to set up a basic single-node vCenter Server instance. You will install the vSphere Web Client and use its in-browser interface to add ESXi hosts to your vSphere inventory.

1. Log on the system as administrator and start at least one ESXi host.
2. Install ESXi using the vCenter Simple Install option using the instructions provided in the VMware vSphere documentation (<https://docs.vmware.com/en/VMware-vSphere/index.html>).
3. Install the vSphere Web Client using the instructions provided in the VMware vSphere documentation.

12.3.2. Configure passthrough devices on a host

Follow the steps below to add ESXi hosts to the vCenter Server inventory, in order to create a vSphere environment and use vSphere features.

1. Enter the IP address, username and root password of your host created when you installed ESXi.
2. Select **Login**, the **Getting Started** page will be displayed.

3. Select the **Configuration** tab.
4. Select **Advanced Settings**.
5. Select **Configure Passthrough**. The **Passthrough Configuration** page is displayed listing all available passthrough devices.
6. Select **Edit**.
7. Select the check box to mark the endpoint for passthrough.

For example, the check mark box for 02:00.0 will be **Freescale Semiconductor Inc <class> Power PC**.

8. Select **OK**.

ESXi will now be successfully installed and the Solo PCIe module has been configured for passthrough.

12.3.3. Create the VM guest instance

VMware ESXi provides the capability of PCI passthrough and it is a bare metal Hypervisor. This requires the creation of two or more guests which communicate via Vswitch. One of the guest will act as the primary guest and will be configured as described below utilizing the PCI card connected via passthrough. The second and subsequent guests can be composed of the identical configuration with the exception of the PCI passthrough connection.

To create the VM guest instance:

1. Navigate to **File > New > Virtual Machine** in the vSphere Client. A wizard will prompt you through each of the settings displayed in the working pane.
2. Select **Typical Configuration** and then select **Next**.
3. Enter a name and select **Next**.
4. Select a storage device for the VM files.
5. Select a Guest Operating System (OS) and an OS version from the drop down menu.
6. Select **Next**.
7. Configure the network connections as follows:
 - a. How many NICs do you want to connect? **1**.
 - b. Network: **VM Network**.
 - c. Adapter: **VMXNET 3**.
 - d. Connect at Power On: .

8. Select **Next**.
9. Configure the virtual disk size for the guest VM as follows:



It is important to select the same network configuration for both the guest primary VM and the guest secondary VM, as it is a requirement for IP communication between the two.

- a. Datastore: **<datastore1>**.
 - b. Available space (GB): **<357.3>**.
 - c. Virtual disk size: **50 GB**.
 - d. Select **Thick Provisioned Lazy Zeroed**.
10. Select **Next**.
 11. Select **Edit the virtual machine settings before completion**.
 12. Select **Continue**.
 13. Select **Add**.
 14. Select **PCID**.
 15. Select **Next**.
 16. Select the configured PCI passthrough device.

For example, 02:00.0 will be **Freescale Semiconductor Inc <class> Power PC**.
 17. Select **Next**.
 18. Select **Finish**.

12.4. XenServer environments

Install the XenServer, follow the instructions in the *Citrix XenServer Quick Start Guide*, see <https://docs.citrix.com/en-us/xenserver>.

12.4.1. Configure the XenCenter client

To remotely manage VM guests and configure PCI passthrough of the nShield Solo XC:

1. Enter the XenServer web client IP address.
2. Select **XenCenter installer**. The XenCenter software will auto install.
3. Select the XenServer that you want to connect to and manage from the Resources pane. A connection is established providing access to all the VMs installed on the server.

4. Select the **Console** tab from the **Properties** tabs pane.



Dom0 is the initial domain started by the Xen hypervisor on boot. Dom0 runs the Xen management toolstack and is has direct access to the hardware. Dom0 provides Xen virtual disks and network access for VM guests, each VM guest is referred to as a DomU (that is, an unprivileged domain).

5. Run the command `lspci`.

A detailed list of all the PCI buses and devices in the system is displayed, for example:

```
02:00.0 Power PC: Freescale Semiconductor Inc Device 082c (rev11)02:00:0
```

represents the nShield Solo XC card endpoint.

6. Open the file `/boot/extlinux.conf` and scroll to the dom0 Linux kernel append section. Add the PCI slot as shown below with the following command:

```
pciback.hide=(02:00.0)
```



Newer versions of Citrix XenServer utilize:

```
xen-pciback.hide=(xx:xx:x)
```

7. Scroll to the end of the file.
8. Run the command:

```
pciback.hide=<NG solo card endpoint>
```

This command enters the PCI slot, for example:

```
pciback.hide=(02:00.0) --- /boot/initrd-fallback.img
```

9. Save and close the file.
10. Run the command:

```
extlinux -I /boot
```

11. Run the command:

```
reboot
```

12. Run the command:

```
xe vm-list
```

13. Locate the **uuid** using the VI Editor for the VM that you want to assign the PCI passthrough to.

14. Run the command:

```
xe vm-param-set other-config:pci=0/0000:<endpoint of the N6 solo card> uuid: <uuid>
```

This command adds the PCI device to the selected VM, for example:

```
xe vm-param-set other-config:pci=0/0000:02:00.0 uuid: 4a4ab965-a91d-70e7-2ec-a4c0004e1e8d
```

If a PCI passthrough needs to be removed from a specific guest VM, run the command:

```
xe vm-param-clear param-name=other-config uuid=<vm uuid>
```

When the installation of XenCenter has completed, you can access [[**https://\(XENSERVERIP\)**](https://(XENSERVERIP))] to acquire the corresponding XenCenter Client Remote management interface.

12.4.2. Create a XenServer guest instance and hardserver configuration

The XenServer is a bare metal Hypervisor that provides the PCI passthrough capability. As part of this process, you must create two **Dom U** guests that communicate through the Vswitch. One guest acts as the primary guest and is configured as described below utilizing the PCI card connected via passthrough. The second guest can be composed of the identical configuration with the exception of the PCI passthrough connection.

To create the first DomU guest VM:

1. Select the server from the **Resources** pane, right-click and select **New VM** from the dropdown menu.
2. Select a **Template**.

3. Select an **Operating system** for the first DomU guest VM.
4. Select **Next**.
5. Select **Name**.
6. Enter a name and select **Next**.



The DomU guest VM name will also be displayed in the XenCenter's Resources pane. You can change the name at any time.

7. Select **Installation Media**.
8. Select **Install from ISO library or DVD drive** and then select the appropriate media from the drop down menu.
9. Select **Next**.
10. Select **Home Server**.
11. Select **Place the VM on this server** and then select a home server from the drop down list of available servers.
12. Select **Next**.
13. Select **CPU & Memory** and enter the number of CPUs, chose your topology and enter an amount for memory.
14. Select **Next**.
15. Select **Storage**.
16. Select **Use these virtual disks:** and select a virtual disk from the display.
17. Select **Next**.
18. Select **Networking** and select the virtual network interface.
19. Select **Finish**.



If the guest VM is configured to have a PCI module via passthrough and the module is not connected to the VM instance, the guest VM instance will fail to power on. Verify that the Solo XC card is located on the same slot that was selected for the passthrough to the guest VM.

12.5. Hyper-V environment



The instructions assume there is a single nShield Solo XC module in the system.



The commands starting with **PS C:\>** should be run in PowerShell

| in elevated mode.

12.5.1. Set up

12.5.1.1. Install Hyper-V on the server

Follow the instructions in the Windows documentation for Hyper-V, see <https://docs.microsoft.com/en-us/windows-server/virtualization/hyper-v/>.

12.5.1.2. Add the Hyper-V role to the server

To add the Hyper-V role in Windows server:

1. Log in as Administrator.
2. Open **Server Manager**.
3. Select **Manage**.
4. Select **Add Roles and Features**.
5. Select **Next**.
6. Select **Role-based or feature-based installation**.
7. Select **Next**.
8. Select **Select a server from the server pool**.
9. Select a server that has Windows 2016 installed. You will be adding Hyper-V to this server.
10. Select **Next**.
11. Select **Hyper-V**.
12. Select **Next**.
13. Reboot the system.

Once rebooted, Hyper-V will be supported by the Server 2016 instance.

12.5.1.3. Prepare the server

1. Enable the Input Output Memory Management Unit (IOMMU) policy on the server. This policy controls whether the Hyper-V server uses an IOMMU. To enable it, run the command:

```
bcdedit /set hypervisoriommpolicy enable
```

2. Check no devices are already set up for VM. Run the command:

```
PS C:\> Get-VMHostAssignableDevice
```

12.5.1.4. Prepare the device

1. Display the device address. Run the command:

```
PS C:\> (Get-PnpDevice -PresentOnly).Where{ $_.InstanceId -like '*VEN_1957*' } | Format-Table -autosize
```

2. Disable the device. Run the command:

```
PS C:\> Disable-PnpDevice -Verbose -InstanceId $instanceId -Confirm:$false
```



To find the **\$instanceId** run the command:

```
PS C:\> $instanceId = (Get-PnpDevice -PresentOnly).Where{ $_.InstanceId -like '*VEN_1957*' } | select -expand InstanceId
```

3. Dismount the device. Run the command:

```
PS C:\> $locationPath = Dismount-VmHostAssignableDevice -LocationPath $locationPath -Force -Verbose
```



To find the **\$locationPath** run the command:

```
PS C:\> $locationPath = (Get-PnpDeviceProperty -KeyName DEVPKEY_Device_LocationPaths -InstanceId $instanceId).Data[0]
```

4. Verify that the device is disabled and dismantled. Run the command:

```
PS C:\> Get-VMHostAssignableDevice
```

12.5.1.5. Install the Security World software

Install the Security World software suite into the operating system of the guest VM. Once the suite is installed, you can initialize the hardserver and then configure the guest VMs.

1. Insert the DVD-ROM containing the Security World software. The Security World software will auto install.
2. Run the **enquiry** utility to check that the module is working correctly. See

Checking the installation.

12.5.1.6. Create the VM guest instance on the server

1. Open the Hyper-V Manager within your Windows 2016 server.
2. Log in as Administrator.
3. Navigate to **Action > New > Virtual Machine**.
4. Select **Next** (to create a virtual machine with a custom configuration).
5. Enter a name for the new guest VM instance.



Use the default location setting.

6. Select **Next**.
7. Select the OS generation to be installed on the new guest VM instance.



For example, **Generation 2** is selected. **Generation 2** is valid for products such as Windows 8 and beyond and with Windows Server 2016.

8. Select **Next**.
9. Select an amount of memory for allocation to this guest VM instance.
10. Select **Next**.
11. Select **Next**.
12. Select **Create a virtual hard disk**.
13. Enter **Name**, **Location** and **Size**.
14. Select **Next**.
15. Select one of the following options:
 - **Install an operating system later**, if you have a disk.
 - **Install an operating system from a bootable image file**, if you have the ISO path.
16. Select **Next**.
17. Select **Finish**.

12.5.1.7. Configure the VM guest instance on the server

1. Stop and select the VM guest instance. Run the commands:

```
PS C:\> $vmName = 'ws2016'
```

```
PS C:\> Stop-VM -VMName $vmName
```

2. Turn off the Automatic Stop Action. Run the command:

```
PS C:\> Set-VM -VMName $vm Name -AutomaticStopAction TurnOff
```

3. Make sure the memory minimum bytes match the memory startup bytes. Run the command:

```
PS C:\> Set-VM -VM $vm -DynamicMemory -MemoryMinimumBytes 4096MB -MemoryMaximumBytes 16384MB  
-MemoryStartupBytes 4096MB
```

4. Assign a device to the VM guest instance. Run the commands:

```
PS C:\> Add-VMAssignableDevice -VM $vmName -LocationPath $locationPath -Verbose
```

```
PS C:\> Start-VM -VMName $vmName
```



To find the \$locationPath run the command:

```
PS C:\> $locationPath = (Get-PnpDeviceProperty -KeyName  
DEVPKEY_Device_LocationPaths -InstanceId $instanceId).Data[0]
```



It is possible to assign the same device to a single VM guest instance multiple times. In this case the VM will not start. To check currently assigned devices, run the command below. To remove an assigned device see [Remove a device from the VM guest instance](#).

```
PS C:\> Get-VMAssignableDevice -VMName $vmName
```

12.5.2. Remove a device from the VM guest instance

1. Remove a device from the VM. Run the commands:

```
PS C:\> $vmName = "ws2016"
```

```
PS C:\> Remove-VMAssignableDevice -Verbose -VMName $vmName}
```

12.5.3. Undo passthrough

1. Mount a single device. Run the command:

```
Mount-VMHostAssignableDevice -Verbose -LocationPath $locationPath
```



To find the **\$locationPath** run the command:

```
PS C:\> $locationPath = (Get-PnpDeviceProperty -KeyName  
DEVKEY_Device_LocationPaths -InstanceId $instanceId).Data[0]
```

2. Enable a single device in device manager. Run the command:

```
Enable-PnpDevice -Confirm:$false -Verbose -InstanceId $instanceId
```



To find the **\$locationPath** run the command:

```
PS C:\> $locationPath = (Get-PnpDeviceProperty -KeyName  
DEVKEY_Device_LocationPaths -InstanceId $instanceId).Data[0]
```